

Instruction Manual

DE38

Digital Differential Pressure Transmitter / Switch

Table of contents

- 1 Safety Instructions
- 2 Intended Applications
- 3 Product Description and Functions
- 4 Installation
- 5 Starting Operation
- 6 Maintenance
- 7 Transport
- 8 Service
- 9 Accessories
- 10 Disposal
- 11 Specifications
- 12 Dimensions
- 13 Ordering Code
- 14 EC Declaration of conformity

1 Safety Instructions

1.1 General information



This operating manual contains detailed information about the installation, operation and maintenance of the instrument.

This information must be observed and read by the installer, operator and other skilled personnel prior to any installation and commissioning of the instrument.

This operating manual forms part of the product and must be kept in the immediate vicinity of the instrument for easy access by the responsible personnel at any time.

The following chapters, especially the instructions on installation, commissioning and maintenance contain important safety information, the non-compliance of which may result in hazards to persons, animals, environment and objects.

1.2 Personnel qualification

Only personnel trained in the installation, commissioning and operation of this product may install and operate the same.

Skilled personnel are persons who are able to judge delegated work and possible hazards based on their technical education, proficiency and experiences, particularly due to their knowledge about the applicable norms.



1.3 Risks of non-compliance with safety instructions

Non-compliance with these safety instructions, inappropriate use of this product, and/or operation of this product outside the limits specified for any of its technical parameters, may result in harm to persons, the environment or the system in which it is installed.

The producer is not liable for any claims for damages in such circumstances.

1.4 Safety instructions for operators

Safety instructions for the proper use of this product must be followed. This information must be available at all times to personnel responsible for installation, operation, maintenance and inspection of this product.

Adequate steps must be taken to prevent the occurrence of hazardous conditions that can be caused by electric energy and the convertible energy of the process media and/or improper connection of the instrument. Detailed information can be found in the relevant national and/or international rules and regulations.

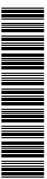
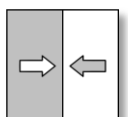

In Germany DIN EN, UVV apply, for industry-specific applications regulations of DVGW, Ex, GL, as well as the rules of the local authorities (e.g. EVUs in Germany).

1.5 Forbidden modifications

Modification or other technical alteration of the device by the customer is not permissible. This also applies for the use of spare parts. Any eventual modifications/ variations will be carried out solely by Fischer Mess- und Regeltechnik GmbH.

1.6 Impermissible operational modes

The operational dependability of the device is guaranteed only if it is used as intended. The device version must be adapted to the medium used in the system. The limiting values stated in the technical data must not be exceeded.

1.7 Safety Considerations during Installation and Maintenance

The safety instructions stated in this manual, existing national regulations on accident prevention and the internal rules and procedures on working, operation and safety of the operator are to be observed.

It is the responsibility of the operator to ensure that only authorised and skilled technical personnel carry out any required maintenance, inspection and installation works.

1.8 Explanation of symbols



WARNING!

... indicates a possible hazardous situation the non-observance of which might result in hazards to humans, animals, environment and objects.



INFORMATION!

... points out important information for efficient and trouble-free operation.



TIP!

... points out useful recommendations that are not necessarily required for operation that might however be of use in certain situations.

2 Intended Applications

The product includes the functions of sensing, signal conversion, display, signal transmission, and limit detection of pressure / differential pressure of gases and liquids. The product must be used only for applications and under conditions specified by the manufacturer. In case of uncertainties, the user should consult the manufacturer before installing and using the product.

3 Product Description and Functions

3.1 Block Schematic Diagram

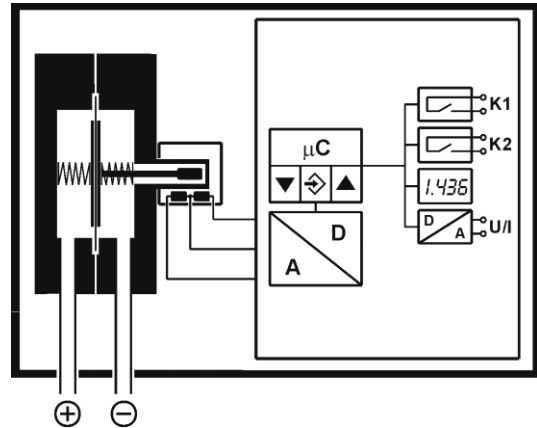

3.2 Principles of Operation

The instrument uses a tough, flexible sensing diaphragm embedded between stiffening plates and balanced by springs on either side. The diaphragm is at zero position when pressures on either side of the diaphragm are equal. Inequality of pressures results in deflecting the diaphragm towards the lower pressure side until a new equilibrium determined by the changed balance of forces is reached. Fastened to the center of the diaphragm is an axial rod, the other end of which forms the moving core of an inductive displacement transducer. The linear displacement of the core is proportional to the pressure difference across the diaphragm. This displacement is converted by the transmitter's electronic module to a standard electrical signal output. An optional output signal can be slew rate limited, spreaded, inverted and piecewise transformed non-linearly by means of a table function.

4 Installation

The electronic module is mounted on a flat plate or panel, for which it has 4 holes at the rear for self-tapping screws $\varnothing 3.5\text{mm}$.

A wall-mounting rear adaptor plate is available as an option (s. Ordering Code).

The pressure transmitters are calibrated at the factory while mounted vertically, pressure ports downward. However, they can be mounted in any orientation. If they are installed with any orientation other than vertical (pressure ports downward), the zero point must be reset (s. section 5.3.2).

IP65 protection for the housing is guaranteed only if suitable connecting cable is used.

If the instrument is intended for outdoor application, we highly recommend using an adequate protective housing (or at least a big enough shelter) as permanent protection against UV-radiation on the membrane keyboard and against exposure of the instrument to rain or snow.

4.1 Process Connections

- Only qualified technicians authorized for this type of work should undertake installation.
- Ensure that the mechanical configuration and materials of construction of the instrument are compatible with the process media.
- Ensure that process equipment and pressure lines are at atmospheric pressure before making pressure connections.
- Pressure lines must have a downward gradient throughout from the pressure instrument to the process vessel/pipe. This is to prevent formation of air/gas pockets (for liquid applications) and liquid plugs (for air/gas applications).
- Pressure lines must be kept as short as possible and must not have short bends to avoid measurement errors induced by pressure line delays.
- The instrument should be provided with suitable protection against pressure surges (e.g., snubber or pulsation damper).
- Ensure that process pressure is always less than the specified safe pressure rating.

The instruments pressure ports are marked by "+" and "-" symbols. For differential pressure applications the "+" port must be connected to the higher pressure and the "-" port should be connected to the lower pressure.

If the pressure transmitter is subjected to pressure when it is started up, zero point checking and adjustment is not possible. In such cases, only electrical connections of the instrument should be made, but not the pressure connections.

4.2 Elektroanschluss

- Only qualified technicians authorized for this type of work should undertake installation.
- Switch off electrical power to the plant before attempting electrical installation work of any kind.
- Do not disconnect under voltage.

3-wire circuit

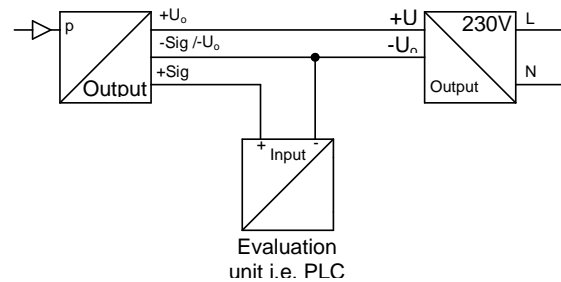

Connector 1: Supply voltage and output signal

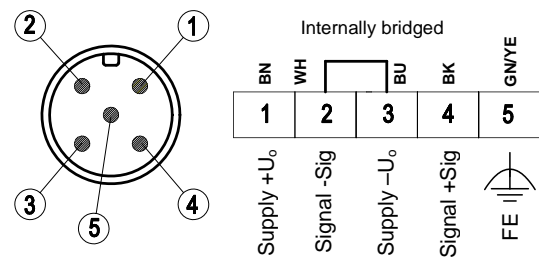

For nominal supply voltage, the operating supply voltage range and the maximum output signal loads see chapter Specifications.

The signal ground line (-Sig) is internally connected to the instrument ground (-Uo), and serves only as an alternative ground connection for the output signal. This usually increases the noise margin.

Connector 2: Switch outputs

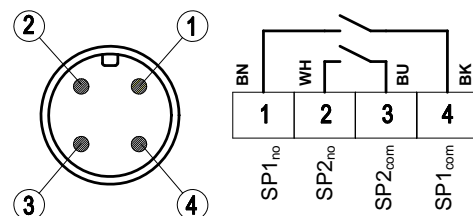

Switching output 1 (SP1) is configured by parameters $r1R$, $r1E$, $r1d$ and $r1F$.

Switching output 2 (SP2) is configured by parameters $r2R$, $r2E$, $r2d$ and $r2F$.

For more information see section 5.3.8.

5 Starting Operation

All electrical supply, operating and measuring lines and the pressure connections must have been correctly installed before commissioning. All supply lines shall be arranged such that there are no mechanical forces acting on the device.

Check the leak-tightness of the pressure connections before commissioning.

5.1 Display

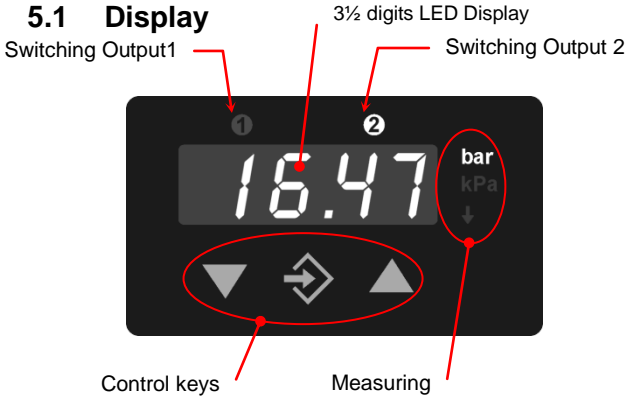

- The 3½ character LED display presents the current differential pressure in normal operating mode.

- The selected measuring unit is highlighted at the right of the display.

 The units represented on the screen may deviate from the actual design.

- Above the display, two LEDs ① ② symbolise the condition of the switching outputs. As soon as the switch is closed, the applicable LED lights up.

5.2 Control keys

The control keys have the following functions:

▼	Menu down Decrease value
◆	Enter key
▲	Menu up Increase value

By using the middle ◆ key on the membrane keypad you can access the parameter menu (settings mode). The display now shows the text *ESC*.

By using the right ▲ key you can move up within the menu and can now select numerous parameters.

By pressing the left ▼ key, you can move downwards in the menu and finally get back to the *ESC* parameter.

By pressing the middle ◆ key you can call up a parameter.

Using the ▼ and ▲ keys, you can then set the parameter value.

In order to take on the adjusted parameter value, press the ◆ key.

All adjusted parameters are first then saved if you leave the menu via the *ESC* parameter.

5.3 Configuration

For commissioning there is a multitude of setting options for optimum adaptation of the device to the measuring point and task at hand. This section covers these options step by step.

Depending on the device design available,¹ some menu points are not available. For example, all characteristic curve functions are masked from the menu if the device does not have a signal output.



The device can be completely set conveniently on the PC using a PC adaptor. There all parameters are immediately visible and accessible. In addition, the complete configuration can be loaded, saved and documented as a control print-out. Further guidelines on this program can be found in the documentation for this program (see accessories).

5.3.1 General

Put the device electrically into operation and ensure that the device is initially depressurised (if necessary, disconnect the pressure connection lines).

In order to set a parameter, proceed as follows:

- Press the Enter ◆ key in order to switch into the menu. *ESC* will appear on the display.
- Use the ▼ ▲ arrow keys in order to select a parameter from the list.
- Press the Enter ◆ key in order to call up the parameters.
- Use the ▼ ▲ arrow keys to set the required value.
- Use the Enter ◆ key to save the value.

After you have set all the parameters, leave the menu as follows:²

- Using the ▼ ▲ arrow keys, set the *ESC* parameter. You can find this both at the start and at the end of the parameter list.
- Use the Enter ◆ key to leave the menu.

5.3.2 Selection of pressure unit

First select the required pressure measuring unit. The unit currently valid is highlighted on the right next to the figure display. For setting, use the middle ◆ key and then look using the right ▲ key for

¹ With reference to the transmitter signal, voltage output, current output etc.

² Only when you leave the menu via the *ESC* parameter are the set parameters valid.

the E_{in} parameter. Press \diamond again and then change the value shown using \blacktriangle or \blacktriangledown . After selection, save the value with \diamond and on will appear again in the display.

To complete, leave the settings mode. Press \blacktriangledown until E_{SC} and then \diamond . Now the pressure currently measured is represented. On the right of this, the correct pressure unit should be highlighted.

 The display circumference is limited to ± 1999 . For this reason not all specified pressure units may in individual cases be selectable.

5.3.3 Zero point control and adjustment

Ensure that the device is depressurised (if necessary, disconnect the pressure connection lines).

If the device does not indicate precisely zero, please note the shown value. The oFI parameter enables you to adjust the offset exactly to zero. To do this, you must enter the noted value with the sign reversed, and save it under oFI .

 The entered value is purely a number value; no decimal point is shown

If the device has already been used, values for the oFI and nP parameters may have been entered. In this case please set both parameter values to zero and carry out the zero point alignment again.

After zero-point adjustment, the pressure sensing lines can be reconnected.

5.3.4 Damping and zero-point stabilizing

If there are unsteady pressure readings at this point of time or during operation, you can use parameters dRN and nP to stabilise the reading (and the output signal).

The dRN parameter acts like a capillary throttle. However, it only has an effect on the display, the output signal and the switch points but not on the measuring cell itself. You can set the response time to pressure jumps using this parameter. The values range comprehends 0.0 to 100.0 seconds.

 With maximum damping, it will take more than 2 minutes for the reading also to reach zero after a pressure jump from nominal pressure (100 %) to zero.

In many cases, unsteady readings are not a problem during normal operating mode, but this is not true for the idle state, i.e. if zero (differential) pressure is expected.

In such situations, parameter nP can be applied. Its value defines a measuring value range of around zero. The measuring value is set to zero within this range.

Example:

For nP , a value of 0.08 mbar^3 is entered. In this case all pressures which lie within a range of -0.08 mbar to $+0.08 \text{ mbar}$ become zero. Only if the pressure exceeds these limits, will the reading no longer indicate zero. The pressure value and the reading do not however accord one hundred percent with each other. Only after a doubled value, i.e. from 0.16 mbar , will the measuring pressure and the reading match again.

5.3.5 Setting the output signal

The transmitter output signal primarily depends on the measured pressure. However, you have the option to adjust the output signal to a large extent to suit your requirements.

 However, the basic measuring range (indicated on the type label) and the type of output signal (voltage or current) are not variable.

The parameters NR (Start of measuring range) and NE (End of measuring range) define the limits to which the output signal can change at all. Both values are adjustable across the entire basic measuring range. The set values always refer to pressures in the relevant valid pressure unit and are converted when the unit is changed.

The allocated signal values for NR and NE cannot be changed (see type label, e.g. $0...10 \text{ V}$ or $4...20 \text{ mA}$).

If $NR < NE$, we speak of a rising characteristic curve. The output signal increases as the pressure rises.

If $NR > NE$, we speak of a falling characteristic curve and the output signal decreases as the pressure rises.

The difference between values NR and NE must be at least 25 % of the basic measuring range. The software will not allow larger spreads. You will not be able to exit the menu if you have entered incorrect range values.

Example:

With a basic measuring range of 400 Pa , the following must apply: $NR - NE \geq 100 \text{ Pa}$.

5.3.6 Output signal limits (Namur)

The three parameters $oG1$, $oG2$ and oEr determine independent of the pressure, the limit values for output currents or voltages which must not be underrun or exceeded.

 These limit values are superordinate to the range determined through NR and NE . They serve mainly to suppress error messages in downstream systems through short-term measuring range exceedances.

³ $0.08 \text{ mbar} \triangleq 8 \text{ Pa}$

With the **oGI** parameter, the limit value for the minimum output signal is determined. The output signal cannot underrun this value. Generally this parameter is only expedient for devices with an output signal of 4...20 mA, because on these devices a value below 3.8 mA is often evaluated as an error signal.

With the **oG2** parameter, the limit value for the maximum output signal is determined. The output signal cannot exceed this value. This parameter can be used for all outputs (voltage and current) in order to limit the maximum value to e.g. 10.2 V.

With the **oEr** parameter, the value for the error signal is determined. The value specified with **oEr** is emitted as an output signal if the device detects an internal error and work no longer correctly. However, not all possible errors and defects can be detected by the device.

If you set **oGI = oG2 = 0**, the output signal is no longer checked for limits.



If you set **oGI** to the maximum value (11 V or 21 mA), you can change using **oG2** the output signal independent of pressure from zero to the maximum value. It is not necessary to leave the menu item; the output is then carried out immediately. You then operate the device as a signal transmitter and can then easily check the other signal processing.

5.3.7 Characteristic curve function **F**

For certain applications, a pressure measurement is only an indirect measurement for the actual variable. Flow measurement across an aperture or filling level determination through hydrostatic pressure measurement are two typical examples of this. In these cases it may be necessary to change the output signal of the transmitter through a non-linear characteristic curve so that the subsequent evaluation receives a signal linearly proportional to the actual measured value (e.g. volume in m³ or volume flow in cm³/s etc.)

The **F** parameter allows you to select between the following variants:

F	Characteristic curve
0	Linear characteristic curve (standard)
1	Root-extracted characteristic curve
2	Horizontal cylindrical tank
3...30	Support point table with 3 to 30 value pairs

Whenever you change the value of **F**, the program will create a new table. All previous table values are rejected and replaced with new linear entries.

The tables for types **F = 0** to **F = 2** are not visible. Here internal values are used for table calculation. These values cannot be modified.

For **F = 3...30**, you only have influence on the 1...28 intermediate values (see section 5.3.7) you only

have access to the start and end value via the **NR** and **NE** parameters.

If the parameters **NR** and **NE** are changed, the table will be deleted and **F = 0** is set.

At the start of measuring range (**NR**), 0% is emitted by the output signal (e.g. 0 mA).

At the end of measuring range (**NE**), 100% is emitted by the output signal (e.g. 20 mA).

5.3.8 Menu jump **Lin**

If the value of **F** is larger than or the same as 3, there is a submenu **Lin**. Here you can access all table values except for the start of the table (**NR**) and the end (**NE**).

This submenu has its own entry and exit point, which is represented with **End**. The table is not saved until you switch back to this point in the main menu, meaning that you switch back using the key to the **Lin** parameter.

If the table is not structured correctly, an error message **Err** will appear at this point, and you will not be able to exit the submenu.

The table consists of 2...29 value pairs. On a device with a power output, the first value pair is **{.02|P02}**⁴. The initial value **.02** determines the level of the output signal. The second value **P02** determines at which pressure the output signal should be emitted.

Then come the value pairs **{.03|P03} ... {.29|P29}**.

The entry of or changes to the table values via the membrane keyboard is extremely strenuous and prone to errors. It is only intended as an emergency solution in case access to the PC adaptor is not possible.

The table is correct if the following applies for all signal values: the value is larger than the previous value. For the pressure values, therefore, either the larger (rising characteristic curve) or the lower (falling characteristic curve) apply accordingly. A transition from a rising to a falling characteristic curve or vice versa is not permitted.

5.3.9 Switch Points

The two switching outputs **1** **2** are configured through four parameters each.

The function of the switching output **1** is determined through the parameters **r1R**, **r1E**, **r1d** and **r1F**.

The function of the switching output **2** is determined through the parameters **r2R**, **r2E**, **r2d** and **r2F**.

r1R determines the switch-off point, and **r1E** determines the switch-on point for switching output 1.

⁴ With a voltage output **{.02|P02} ... {.29|P29}**.

The values are set in the valid measuring unit (shown on the right).

Together, both the rIA and rIE parameters determine the switching function of switching output 1:

If rIA is smaller than rIE , the output switches on if the measuring value exceeds rIE . It does not switch off until the measuring value underruns rIA (hysteresis function).

If rIA and rIE are equal, the output switches on if the measuring value exceeds rIE and off if the measuring value underruns rIA .

If rIA is larger than rIE , the output switches on if $rIE < \text{measuring value} < rIA$ applies (window function).

Both parameters can be set independently across the entire measuring range.

If the measuring unit is switched, the switch points are recalculated accordingly. Here rounding errors may cause deviations in the last point.

rId allows the reaction of the switching output 1 to be delayed by 0.0 to 100.0 s. This value applies equally for switch-on and switch-off.

rIF reverses the function of the switching output. If the value = 1, the switching output functions as an NO contact, if the value = 2, the switching output functions as an NC contact.

5.3.10 Password

The last menu item $-P-$ serves for the input of a password. A value of 001 to 999 can be selected as a password. The value 000 renders the password function invalid.

If a password was assigned, a text PAS is shown after ESC and \diamond , and you must enter the right value by using \diamond and $\blacktriangle/\blacktriangledown$. Only by doing so will you be able to access all other menu items. In the event of an error, the reading goes back to the start of the menu ESC .

 If the password is forgotten, it can only be reset by the manufacturer or overwritten via the PC adapter.

5.3.11 Display Options

The $d0$ parameter permits the reading to be steadied if the measuring value fluctuates severely. This filter function is similar to the dAN function, but has an effect only on the display and not on the output signal. With $d0 = -1$, only the switch point LEDs can be controlled. With $d0 = -2$, these are switched off.

5.3.12 Reset to Default values

The rES function serves to reset all settings to default. Default values can only be defined via PC interface.

5.3.13 Free Unit

If the device is designed for a "free" third unit (membrane symbol: \blacktriangledown), the display can be scaled at will using the parameters nAF , nEF and dPF .

The measuring range defined through the parameters nA and nE is converted into nAF and nEF . Here the table function (F) is also taken into account. The value of dPF determines the position of a decimal point.

5.4 Parameter overview

After switching on the device, it will briefly indicate the software version number and then enters the normal operating mode. By using the middle \diamond key on the membrane keypad you can access the parameter menu. The reading now shows the text *ESC*. By using the right \blacktriangle key, you can choose the parameters from the following list one by one:

 **Note:**
Depending on the device design, individual parameters may not be available if the device does not possess this feature.

- PAS** **Enter password**
(only comes up if password is active),
values range 000..999
000 = deactivated
- dAN** **Damping**
(Jump response time T_{90}),
values range 0.0...100.0s
- dO** **Display damping**
Value range -2...0...100.
-2 = Display off, LED switching pt. off
-1 = Display off, LED switching pt. on
0 = Display on, LED switching pt. on
1...100 Display damping
- rIR** **Switch-off point**
From switching output ①
- rIE** **Switch-on point**
From switching output ①
- rId** **Switching delay**
From switching output ①
Values range 0.0 to 100.0s.
This value applies equally for switch-on
and switch-off.
- rIF** **Switching function**
From switching output ②
Values range 1,2
1 = Switching output as NO contact,
2 = Switching output as NC contact
- r2A** **Switch-off point**
From switching output ②
- r2E** **Switch-on point**
From switching output ②
- r2d** **Switching delay**
From switching output ②
Values range 0.0 to 100.0s.
This value applies equally for switching
on or off.
- r2F** **Switching function**
From switching output ②
Values range 1,2
1 = Switching output as NO contact,
2 = Switching output as NC contact

- En** **Measuring range unit**
Values range 1,2,3
The selection is highlighted on the
right-hand side next to the display. Not
all basic measuring ranges allow any
switching. The respective unit size can
only then be selected if the basic
measuring range of the device can be
represented meaningfully
- NR** **Start of measuring range**
The measuring value is set in a way
that results in a minimum output signal.
(e.g.: 0V, 0mA or 4mA).
- NE** **End of measuring range**
The measuring value is set in a way
that results in a maximum output sig-
nal. (e.g.: 10 V or 20 mA).
- dPF** **Position of decimal place**
for free unit.
- NRf** **Measuring range start point**
(displayed value) for free unit.
- NEf** **Measuring range end point**
(displayed value) for free unit
- oF1** **Offset correction measuring input 1**
Value range $-\frac{1}{3}$ FS...0... $+\frac{1}{3}$ FS
- nP** **Zero point stabilisation**
Value range 0... $\frac{1}{3}$ FS
- F** **Characteristic curve function**
Value range 0...30
0 = linear,
1 = root-extracted,
2 = horizontal cylindrical tank
3..30 = table
- Lin** **Menu entry**
Submenu table processing
If $F < 3$, this menu item is masked.
- oG1** **Limit value**
Minimum output signal
- oG2** **Limit value**
Maximum output signal
- oEr** **Error signal**
(Output signal in case of error)
- rES** **Reset**
All parameters to default values (speci-
fication of default values via PC)
- P-** **Password settings**
Value range 000 to 999
The value 000 means no password
protection.

6 Maintenance

The device does not require maintenance.

In order to ensure reliable operation and a long service life of the device we recommend regular checking of the device as follows:

- Check the function in connection with slave components.
- Check the tightness of the pressure connection lines.
- Check the electrical connections.

The exact test cycles have to be adapted to the operating and environmental conditions. The operating manuals of all other devices are also to be observed if there is an interaction of different device components.

7 Transport

The product must be protected against severe impacts. Therefore transport is to be effected only in the packaging intended for transport.

8 Service

All defective or faulty devices are to be sent directly to our repair department. We would like to ask you to coordinate all device returns with our sales department.



Remaining medium in and on dismantled measuring instruments may cause danger to persons, environment and equipment. Take reasonable precautions! Clean the instrument thoroughly if necessary.

9 Accessories

- M12 connectors with pre-wired cable lengths on request.
- PC serial interface adaptor with software model EU03.F300.

10 Disposal

Protect your environment...



Kindly help us protecting the environment and dispose of or recycle the used products in accordance with the relevant regulations.

11 Specifications

Measuring range		mbar	0...400	0...0,6	0...1	0...1,6	0...2,5	0...4	0...6
static operating pressure	bar	max	16				16		
straight line error °	%FS	max	2,5				2,5		
		typ	0,8				0,8		
TC span °°	%FS/10K	max	0,8				0,4		
		typ	0,2				0,2		
TC zero point °°	%FS/10K	max	0,8				0,5		
		typ	0,2				0,2		

° : Straight line error = nonlinearity + hysteresis; at 25°C; pressure within specified range (characteristic linear, not spreaded)

°° : Pressure within specified range (characteristic linear, not spreaded); compensated temperature range 0 to 60°C

	General	
Operating temp. (ambient)	-10 ... 70°C	
Operating temp. (media)	-10 ... 70°C	
Storage temperature	-20 ... 70°C	
Protection class (housing)	IP 65 according to DIN EN 60529	
	Electrical	
Nominal supply voltage	24 V DC/AC	
Operating supply voltage U_o	12 ... 32 V DC/AC	
Electrical connection type	3 wire circuit	
Characteristic curve	programmable (s. section 5.3.6)	
Power consumption	approx. 2 W/VA	
Display	3½ digit LED	
	Output signal	
	0 ... 20 mA resp. 4 ... 20 mA	0 ... 10 V
Signal load	$U_o \leq 26V \quad R_L \leq \frac{U_o - 4V}{0,02A}$	$U_o < 15V \quad R_L \geq 10k\Omega$
	$U_o > 26V \quad R_L \leq 1100\Omega$	$U_o \geq 15V \quad R_L \geq 2k\Omega$
	Programmable switching contacts	
	2 sets of voltage free relay contacts as make (no) or break (nc) contact	2 sets of voltage free solid state relay SPST ⁵ as make (no) or break (nc) contact
U_{max}	32 V AC/DC	3...32 V AC/DC
I_{max}	2 A	0,25 A
P_{max}	64 W/VA	8 W/VA
	Connections	
Process connections	G 1/8 female threads with optional cutting ring fittings for 6 or 8 mm tube	
Electrical connections	Two round-shell multi-pin connector sockets (M12, male) Connector 1: 5-pin power input and analog signal output Connector 2: 4-pin relay contacts / solid-state switch outputs	
	Materials	
Housing	Polyamid PA 6.6	
Media contact	Brass, VITON®, NBR	
	Mounting	
	Rear mounting holes for panel mounting Wall mountable using adaptor plate	

⁵ SPST: Single Pole Single Throw

11.1 Programming

Via membrane key-switches or by using PC-programming interface (EU03 s. accessory); programming mode can be password protected.

Settings	
Damping	0...100 s (10 / 90% step response time) for signal output, display separated
Switching outputs ① ②	activation point, de-activation point, response time delay (0...100 s), as make (no) or break (nc) contact
Measuring range unit	bar, kPa, „free unit“ ↓, start value, end value and decimal place for „free unit“
Zero suppression	0... $\frac{1}{3}$ of measurement range (1)
Output signal	can be set at any point of measuring range (2)
Offset correction	$\pm \frac{1}{3}$ of measurement range (3)
Output characteristic curve	linear, square rooted, horizontal cylindrical tank, table (3...30 entries)
Password	001 ... 999, (000 = password protection disabled)

- (1) Measured value deviations symmetric about zero are set to zero (Used for zero drift suppression).
 (2) Maximum effective turn-down ratio = 4:1. Only the output signal is affected. Transfer function is inverted if start value > end value.
 (3) Zero calibration setting may change with mounting orientation.

12 Dimensions

(All units in mm unless stated otherwise)

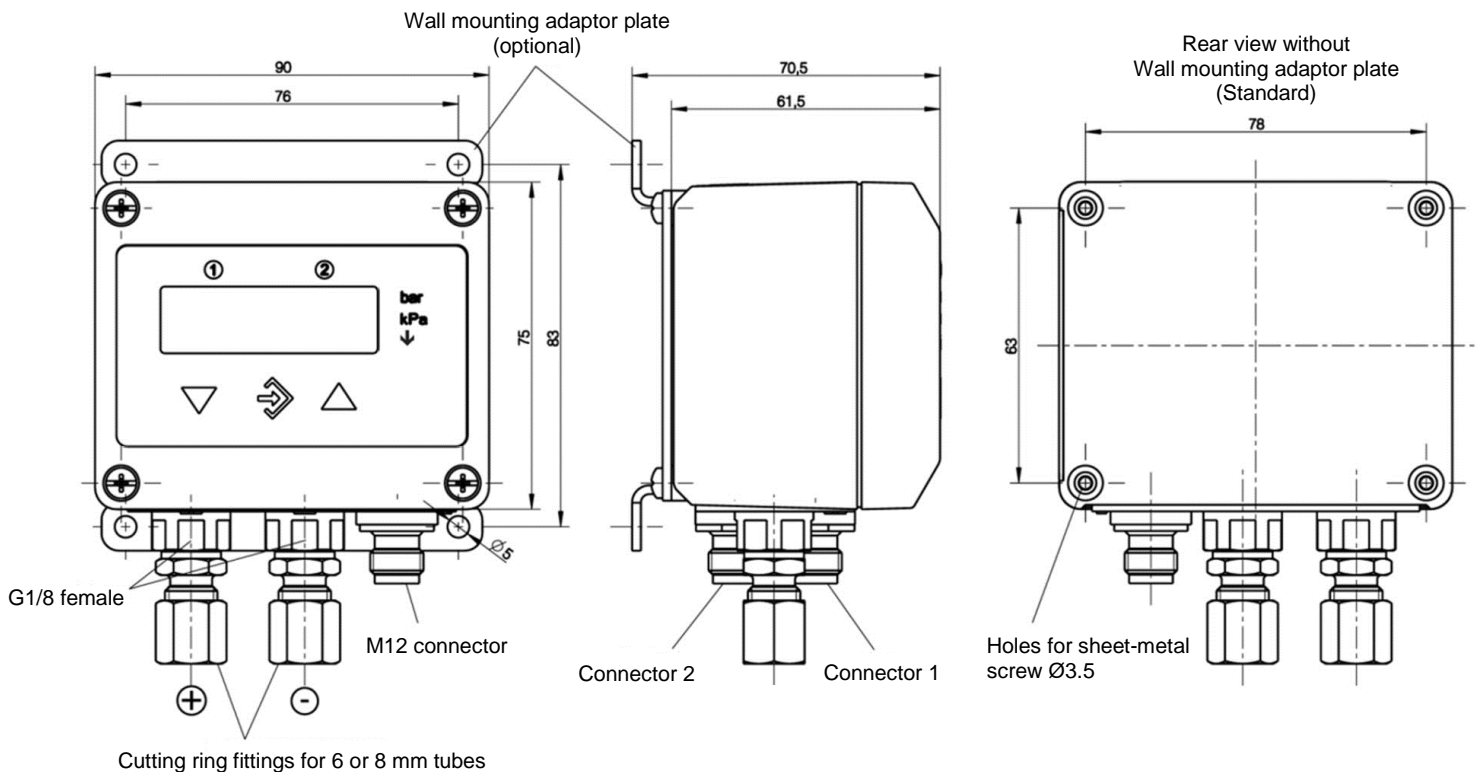

13 Ordering Code

Digital Differential Pressure Transmitter / Switch

Type DE38



Measuring range

- 0 ... 400 mbar.....> 8 3
- 0 ... 0,6 bar.....> 0 1
- 0 ... 1 bar.....> 0 2
- 0 ... 1,6 bar.....> 0 3
- 0 ... 2,5 bar.....> 0 4
- 0 ... 4 bar.....> 0 5
- 0 ... 6 bar.....> 0 6

Measuring system

- Pressure chambers, diaphragm, gaskets: brass / NBR®.....> M
- Pressure chambers, diaphragm, gaskets: brass / Viton®.....> N

Process connections

- G 1/8 female thread.....> 0 0
- Brass cutting ring fitting for 6 mm tube.....> 2 8
- Brass cutting ring fitting for 8 mm tube.....> 2 9

Output signal (3-wire circuit)

- No signal output.....> 0
- Current output: 0 - 20 mA linear.....> A
- Voltage output: 0 - 10 V DC linear.....> C
- Current output: 4 - 20 mA linear.....> P

Supply voltage

- 24 V DC/AC (12 - 32 V DC/AC).....> K

Measuring unit

- Standard pressure units.....> 0

Display / Switching output

- 3½ digit LED display – 2 sets of voltage-free relay contacts.....> 3
- 3½ digit LED display – 2 sets of voltage free solid state relay.....> 6

Electrical connection

- Two round-shell multi-pin connector sockets (M12, male).....> M

Mounting

- Standard (rear fastening holes).....> 0
- Wall mounting.....> W

13.1 Accessories

Ordering code	Description	Pole	Application	Length
06401993	cable with M12 connector	4-pole	switching output	2 m
06401994	cable with M12 connector	4-pole	switching output	5 m
06401995	cable with M12 connector	5-pole	supply and output signal	2 m
06401996	cable with M12 connector	5-pole	supply and output signal	5 m
04005144	wall mounting adapter set			
EU03.F300	PC-programming interface with SW			

14 EC Declaration of conformity

EG-Konformitätserklärung

Wir erklären in alleiniger Verantwortung, dass nachstehend genannte Produkte

EC Declaration of Conformity

We declare under our sole responsibility that the products mentioned below

Digitaler Differenzdrucktransmitter / -schalter / Digital Differential Pressure Transmitter / Switch

DE38 # # # # # # # # # # # # #

gemäß gültigem Datenblatt übereinstimmen mit der

specified by the actual data sheet complies with the

EG-Richtlinie

2004/108/EG (EMV)

EC Directive

2004/108/EC (EMC)

Die Produkte wurden entsprechend der folgenden Normen geprüft (Störfestigkeit für Industriebereich, Störaussendung für Wohnbereich):

DIN EN 61326-1:2004-05
DIN EN 61326-2-3
DIN EN 61010-1:2002-08

The instruments have been tested in compliance with the norms (Immunity for industrial environments, emission for residential environments):

DIN EN 61326-1:2004-05
DIN EN 61326-2-3
DIN EN 61010-1:2002-08

Die Geräte werden gekennzeichnet mit:

The gauges are marked with:



Bad Salzuflen, 07.02.08
(Ort, Datum / place, date)

(rechtsverb. Unterschrift / authorized signature)

